



TRAVIS INDUSTRIES HOUSE OF FIRE

99300687

Thermostat Wall Wireless AGP Pellet Stove GAS Fireplace, Pellet or GAS Insert Only

GAS Fireplace, AGP Pellet Stove or GAS Insert Remote Control Installation Instructions

(LEAVE THE INSTRUCTIONS FOR THE HOMEOWNER)

The Thermostat Wall Wireless Transmitter is a six button transmitter, which turns the GAS Fireplace, AGP Pellet Stove or GAS Insert ON/OFF manually or acts as a thermostat. The display of the transmitter shows the clock, current room temperature, target temperature, timer setting, on/off status, low battery indicator and “*child-proof*”.

Installation Precautions:

The Thermostat Wall Wireless Remote Control is tested safe when installed in accordance with this installation manual. It is your responsibility to read all instruction before starting installation and to follow these instructions carefully during installation.

The Thermostat Wall Wireless Remote Control **MUST** be installed by a qualified service technician.

The Thermostat Wall Wireless Remote Control is carefully engineered and **MUST** be installed only as specified. If you modify it or any of its components, you may possibly cause a fire hazard.

FCC Requirements

Warning: Changes or modifications to this unit not expressly approved by the party responsible for compliance could void the user authority to operate the equipment. This equipment has been tested and found to comply with the limits for a Class B digital device, pursuant to Part 15 to the FCC Rules. These limits are designed to provide reasonable protection against harmful interference in a residential installation. This equipment generates, uses, and can radiate radio frequency energy and, if not installed and used in accordance with the instructions, may cause harmful interference to radio communications. However, there is no guarantee that interference will not occur in a particular installation. If this equipment does cause harmful interference to radio or television reception, which can be determined by turning the equipment off and on, the user is encouraged to try to correct the interference by one or more of the following measures:

- Reorient or relocate the receiver antenna.
- Increase the separation between the equipment and receiver.
- Connect the equipment into an outlet on a circuit different from that to which the receiver is connected.
- Consult the dealer or an experienced radio TV technician for help.

Canadian Equipment Requirements

This digital apparatus does not exceed the (class A/Class B)* limits for radio noise emissions from digital apparatus set out in the Radio Interference Regulations of the Canadian Department of Communications. Le présent appareil numérique n'excède pas de bruits radioélectriques dépassant les limites applicables aux appareils numériques (de la class A/de la class B)* prescrites dans le Règlement sur le brouillage radioélectrique édicté par le ministère des Communications du Canada.

This device complies with RSS-210 of Industry and Science Canada. Operation is subject to the following two conditions : (1) this device may not cause interference, and (2) this device must accept any interference, including interference that may cause undesired operation of the device.

All wiring should be done by a qualified electrician and shall be in compliance with local codes and with the National Electric Code ANSI/NFPA No. 70-current (In the United States), or with the current CSA C22.1 Canadian Electric Code (in Canada).

1.0 Installation Instruction for AGP Pellet Stove

1.1 Installing the Receiver

- 1 Remove the side cover and access panel to both sides of the unit.
- 2 Remove the thermostat bracket and cover plate on the right side.



- 3 Connect wires from the thermostat receiver to the wires labeled "TSTAT" from the main wire harness on the left side of the unit (orientation does not matter).



- 4 Attach the thermostat receiver to the thermostat bracket with 4 screws.



- 5 Replace the receiver and bracket into the cutout on the side of the unit (the cover plate can be discarded).



- 6 Program the receiver to the remote as per the instructions.
- 7 Replace access panels and side covers.

1.2 Installing the Receiver for Gas Fireplace or Insert Wall Mount

- 1 Make sure the slide switch on the Remote Receiver is at the OFF position.
- 2 Gas Appliance Receiver Wire Installation (See *Figure 1*)

We recommend the receiver wires to be installed in a parallel circuit with the on/off switch (switch must be in "OFF" position for remote to work). See the directions below for this type of installation..

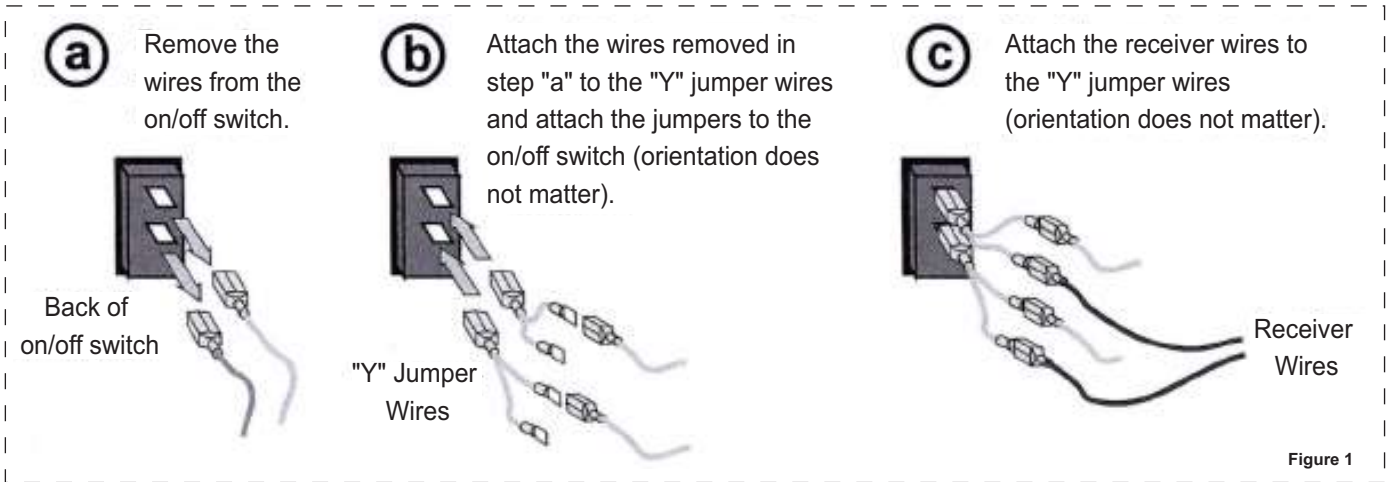

- 3 Installing the Remote Receiver to a Wall Mount:
 - Secure the Remote Receiver to the wall mount.
 - Use the screws provided to secure the face plate to the Remote Receiver. See *Figure 2*.
- 4 Put the switch cap to the slide switch.
- 5 Slide the battery compartment into the Remote Receiver. See *Figure 3*.

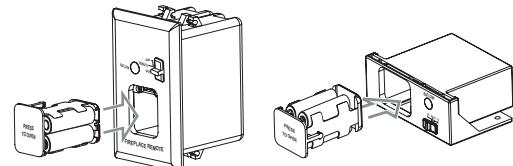
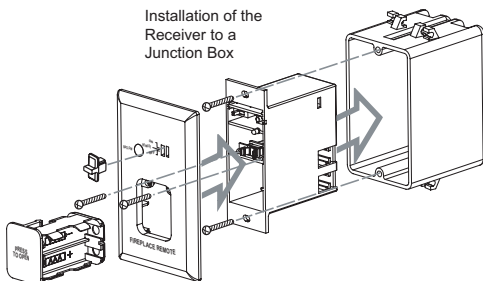

1.3 Installing the Remote wall mount Transmitter

- 1 Install the Wall Mount bracket horizontally onto the wall using the screws provided. See figure 4.
- 2 Slide the Wall Mount Transmitter onto the Wall Mount bracket as shown is figure 5.

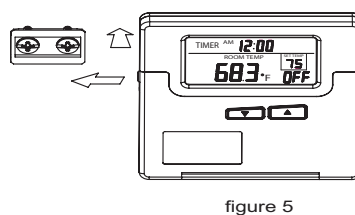
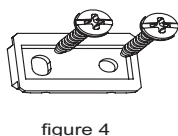



TRAVIS INDUSTRIES HOUSE OF FIRE

99300687

Thermostat Wall Wireless AGP Pellet Stove GAS Fireplace, Pellet or GAS Insert Only

GAS Fireplace, AGP Pellet Stove or GAS Insert Remote Control Operating Instructions For The Homeowner

BEFORE YOU BEGIN:

Warning Read all of the safety precautions in the owner's manual included with your GAS Fireplace, AGP Pellet Stove or GAS Insert before using this remote control. The thermostat is not intended for unattended use.

1.0 INSTALLING FRESH BATTERIES:

Note: It is not necessary to re-set your private code when installing Fresh Batteries. The GAS Fireplace, AGP Pellet Stove or GAS Insert MUST be OFF before replacing transmitter batteries.

1.1 RECEIVER CHANGING BATTERIES: see Figure 1

- 1 The Remote Receiver uses 4 pieces AA-size batteries. Slide the slide switch at the Remote Receiver to the Off position.
- 2 Press the battery compartment slightly into the Remote Receiver and then release. The battery compartment will pop out of the Remote Receiver.
- 3 Slide open the battery door and replace batteries.
- 4 Replace the battery door and slide the battery compartment back into the Remote Receiver.

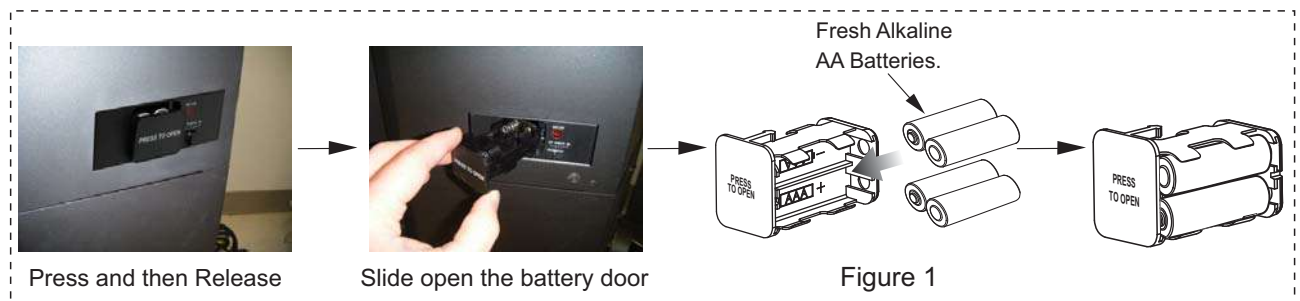

1.2 WALL MOUNT CHANGING BATTERIES: see Figure 2

- 1 The Remote WALL MOUNT uses 3 AAA-size batteries. Replace these batteries at least every 6 months or when the Low battery indicator on the LCD is on.
- 2 Press the battery compartment slightly into the Remote WALL MOUNT and then release. The battery compartment will pop out of the Remote WALL MOUNT.
- 3 Slide open the battery door and replace batteries.
- 4 Replace the battery door and slide the battery compartment back into the Remote WALL MOUNT.
- 5 After you take out the batteries, wait for at least 1 minute before putting fresh batteries into the Remote WALL MOUNT and Receiver.
- 6 Use fresh alkaline batteries only.

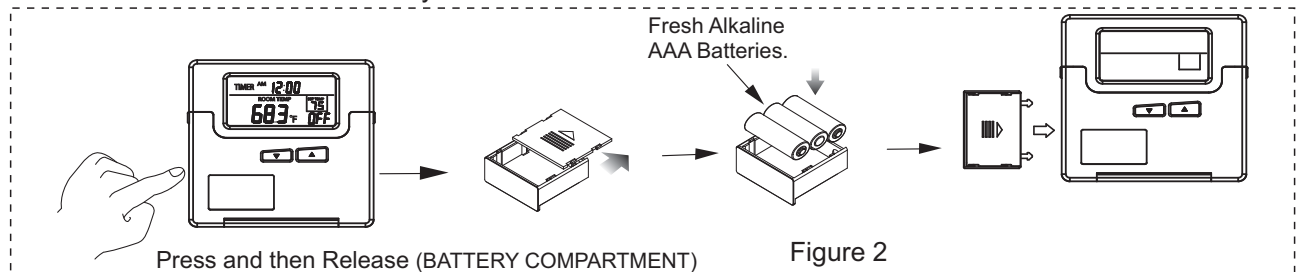

WARNING: THE REMOTE WALL MOUNT WILL AUTOMATICALLY SWITCH OFF THE GAS Fireplace, AGP Pellet Stove or GAS Insert WHEN THE BATTERIES IN THE REMOTE WALL MOUNT IS LOW.

2.0 OPERATION INSTRUCTIONS:

2.1 Wall Mount Transmitter Operation

The Thermostat Wall Wireless AGP Remote Control has 3 operating modes. They are: Manual, Auto and Timer. Use the Up and Down buttons to set the target temperature between 45°F and 90 °F, or 8 °C and 32 °C.

A. Settings : see Figure 3

- 1 Press and hold clock button for about 2 seconds.
- 2 The hour display will flash. Use the Up and Down buttons to set the hour.
- 3 Press the clock button again and the minute display will flash. Use the Up and Down buttons to set the minutes.
- 4 Press the clock button again and the oF or oC display will flash. Use the Up and Down button to select the Remote Transmitter to display temperature in oF or oC.
- 5 Press the clock button again to exit setting.

Figure 3

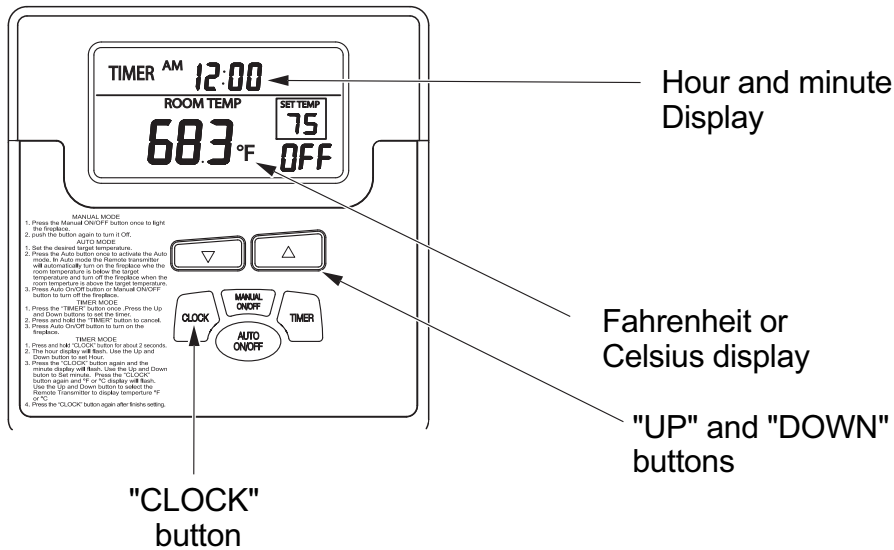

B. Manual Mode: see Figure 4

- 1 Press the Manual On/Off button once to light the GAS Fireplace, AGP Pellet Stove or GAS Insert. Push the button again to turn it off.
- 2 In Manual mode the Remote Transmitter will not turn the GAS Fireplace, AGP Pellet Stove or GAS Insert off even if the room temperature exceeds the target temperature.
- 3 The GAS Fireplace, AGP Pellet Stove or GAS Insert will automatic turn off after 6 hours.

Figure 4

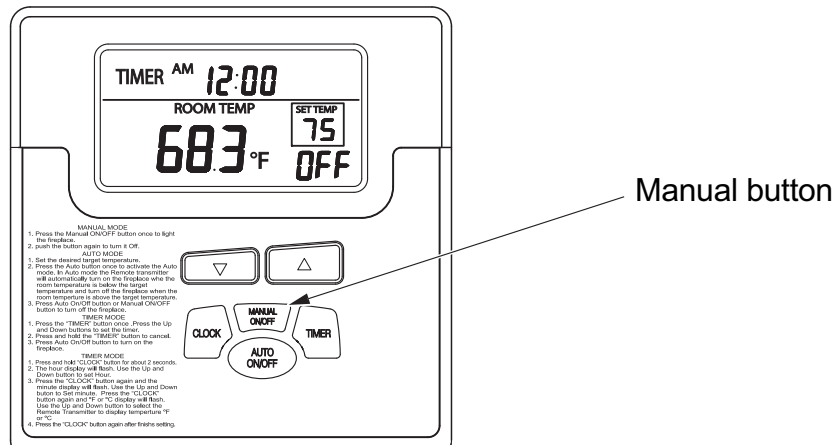

C. Auto Mode: see Figure 5

- 1 Set the desired target temperature.
- 2 Press the Auto On/Off button once to activate the Auto mode. In Auto Mode the Remote Transmitter will automatically turn on the GAS Fireplace, AGP Pellet Stove or GAS Insert when the room temperature is below the target temperature and turn off the GAS Fireplace, AGP Pellet Stove or GAS Insert when the room temperature is above the target temperature.
- 3 Press Auto On/Off button or Manual On/Off buttons to turn off the GAS Fireplace, AGP Pellet Stove or GAS Insert (if it is already on) and exit Auto Mode. **WARNING: IT TAKES SOME TIME FOR THE RECEIVER TO RESPOND TO THE TRANSMITTER. DO NOT PRESS THE MANUAL OR AUTO ON/OFF BUTTONS MORE THAN ONCE WITHIN 2 SECONDS FOR CORRECT OPERATION.**

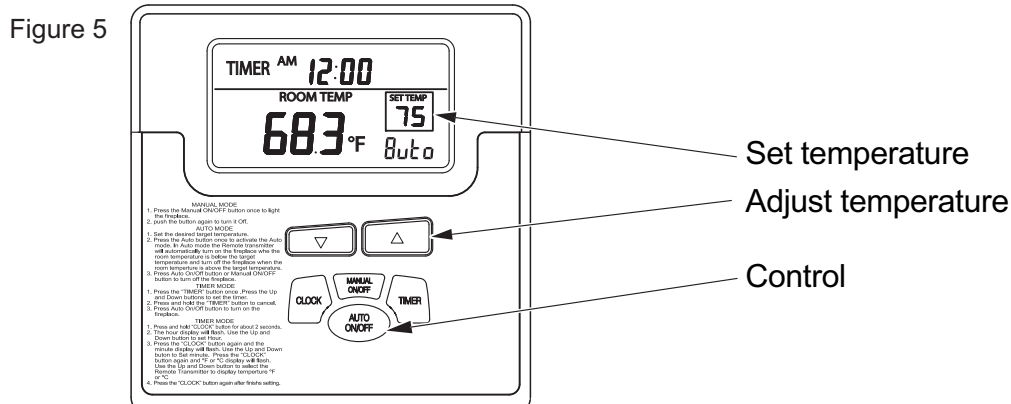

D. Timer Mode: see Figure 6

- 1 You can set the timer to the length of time you want the GAS Fireplace, AGP Pellet Stove or GAS Insert to operate (1 to 120 minutes).
- 2 Press the "TIMER" button once. The Timer display "----" will blink.
- 3 Press the Up and Down buttons to set the timer. The LCD will display the time chosen.
- 4 The timer setting can be cancelled at any time by press and hold the "TIMER" button.
- 5 Press Manual or Auto On/Off button to turn on the GAS Fireplace, AGP Pellet Stove or GAS Insert.
- 6 The GAS Fireplace, AGP Pellet Stove or GAS Insert will turn off at the end of the timer setting.

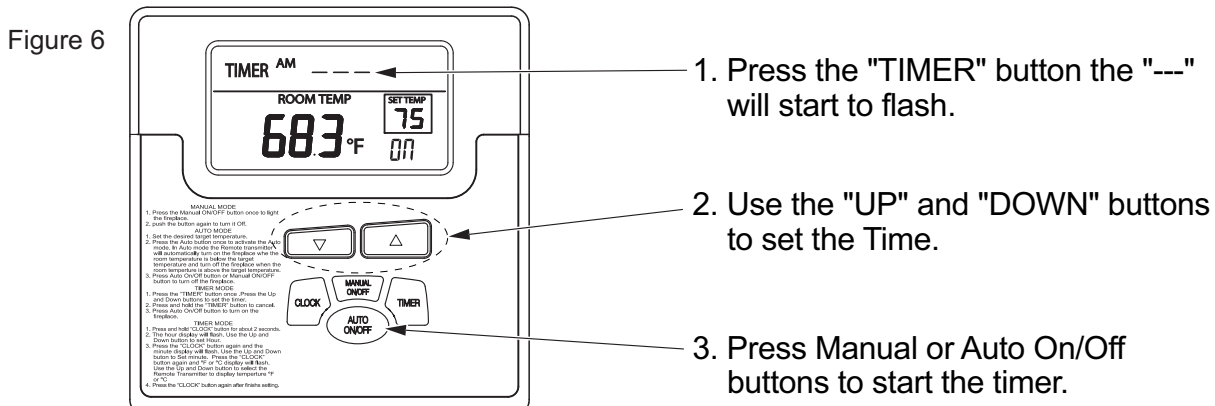

E. Child-Proof Function : see Figure 7

- 1 There is a CHILD-PROOF switch at the back of the Remote Transmitter.
- 2 Slide the CHILD-PROOF switch to position marked C/P to activate the CHILD-PROOF function and the child-proof function icon will appear on the LCD.
- 3 In CHILD-PROOF the Remote Transmitter will not operate the Remote Receiver until the "child-proof" code is used or the switch is returned to the other position.
- 4 Press the Up and Down buttons in the following sequence: **Up-Down-Down-Up-Down**, within 2seconds, button function will be temporarily restored, the child-proof function icon will disappear from the LCD.
- 5 If no button is pressed within 2 minutes, the Remote Transmitter will return to the Child-Proof function and the child-proof function icon will reappear on the LCD until the Child-Proof switch is slide back to the other position.

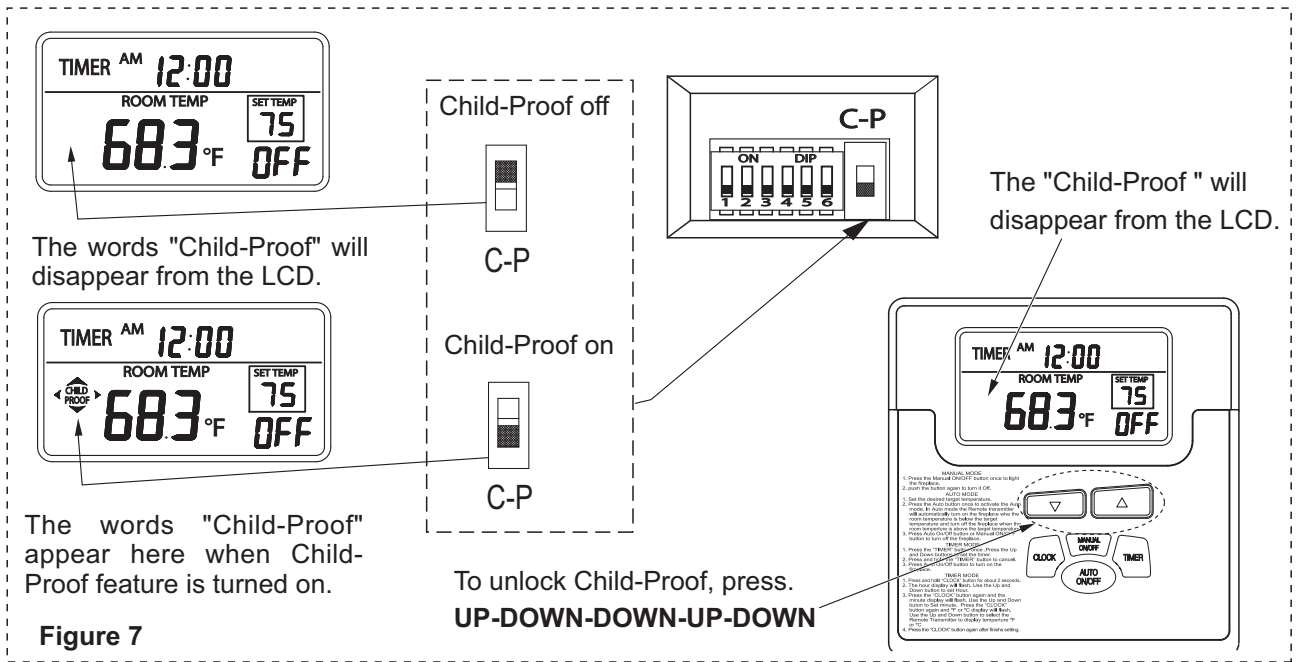

2.2 RECEIVER OPERATION: see figure 8

The Remote Receiver has 3 operation modes. They are ON, OFF and Remote modes.

- A. "ON" Mode: The Receiver will turn on the GAS Fireplace, AGP Pellet Stove or GAS Insert and not responding to the wall mount Transmitter.
- B. "Remote" Mode: The Receiver will respond to the Wall Mount Transmitter and turn the Fireplace, Pellet Stove or Insert on and off accordingly.
- C. "OFF" Mode: The Receiver will Close the GAS Fireplace, AGP Pellet Stove or GAS Insert and not responding to the wall mount Transmitter .

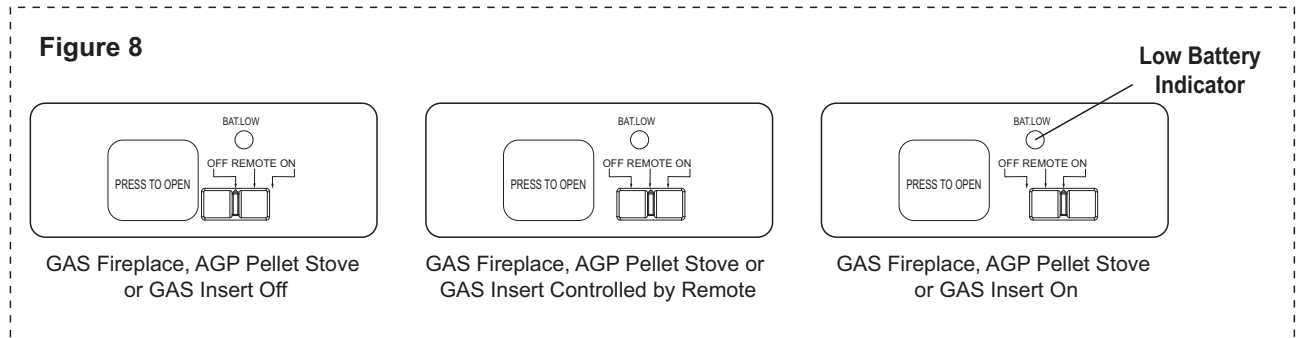

ATTENTION: IMPORTANT SAFETY FEATURE see figure 9

6HR Safety Timer(FACTORY DEFAULT IS "ON")

Enable - Timer Set to "ON"

In case of Transmitter failure (Malfunction / Battery run out) or out of transmission range, The Receiver will shut down the GAS Fireplace, AGP Pellet Stove or GAS Insert automatically after 6Hr of no Transmitter signal detection.

Disable - Timer Set to "OFF"

The Receiver & GAS Fireplace, AGP Pellet Stove or GAS Insert will continue operate in the last setting and will not shut off automatically even in case of Transmitter failure. (Note: Not recommended)

Figure 9

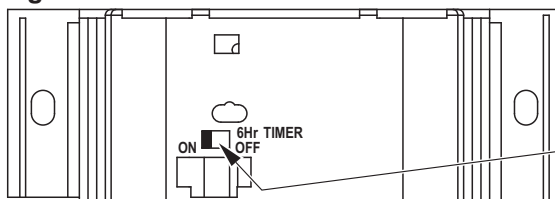

	First 2Hr since last signal received	Following 4Hr	6 th Hr since last signal received
Receiver / GAS Fireplace, AGP Pellet Stove or GAS Insert Status	ON	Intermittent and Check For Transmitter Signal	Shut down if no signal received
NOTE: AUTO MODE ONLY			

3.0 IMPORTANT SAFETY FEATURE: See Figure 10.

You can set a private code into your system to prevent accidental operation by another transmitter nearby.

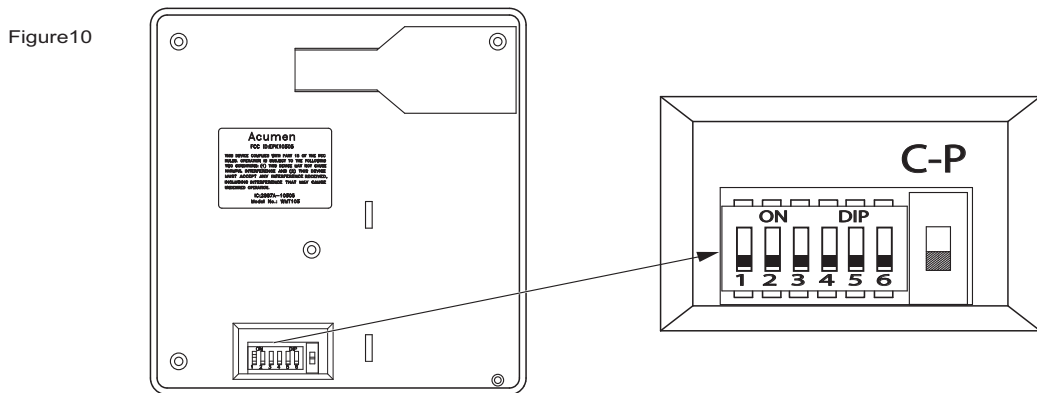

3.1 Coding Instructions: see figure 11

- 1 There are code switches at the back of the Remote Wall Mount. Slide the code switches to your choice of ON or OFF positions. FACTORY SETTING IS ALL 'OFF'.
- 2 Make sure the slide switch on the Remote Receiver is at the OFF position.
- 3 Take the Remote Wall Mount close to the GAS Fireplace, AGP Pellet Stove or GAS Insert or the Remote Receiver (less than 2-10 feet from the GAS Fireplace, AGP Pellet Stove or GAS Insert or Remote Receiver is recommended.)
- 4 Slide the slide switch on the Remote Receiver to REMOTE position.
- 5 Install fresh AAA alkaline batteries into the Remote Wall Mount.
- 6 Press any button on the Remote Wall Mount. The Remote Receiver will produce a 'beep' sound when it receives the code from the Remote Wall Mount. The system is now ready to operate.
- 7 If you do not hear a 'beep' sound from the Remote Receiver, remove batteries from the Remote Wall Mount and slide the slide switch on the remote receiver to OFF position, wait for 1 minute, and repeat step 3 to 6.
- 8 If you desire to operate multiple Remote Receivers with the one Remote Wall Mount, continue to hold the button on the Remote Wall Mount as you bring the Remote Wall Mount within 5 feet of each Remote Receiver then slide the slide switch on the Remote Receivers to the REMOTE position. Each will acknowledge receipt of coding with a beep.

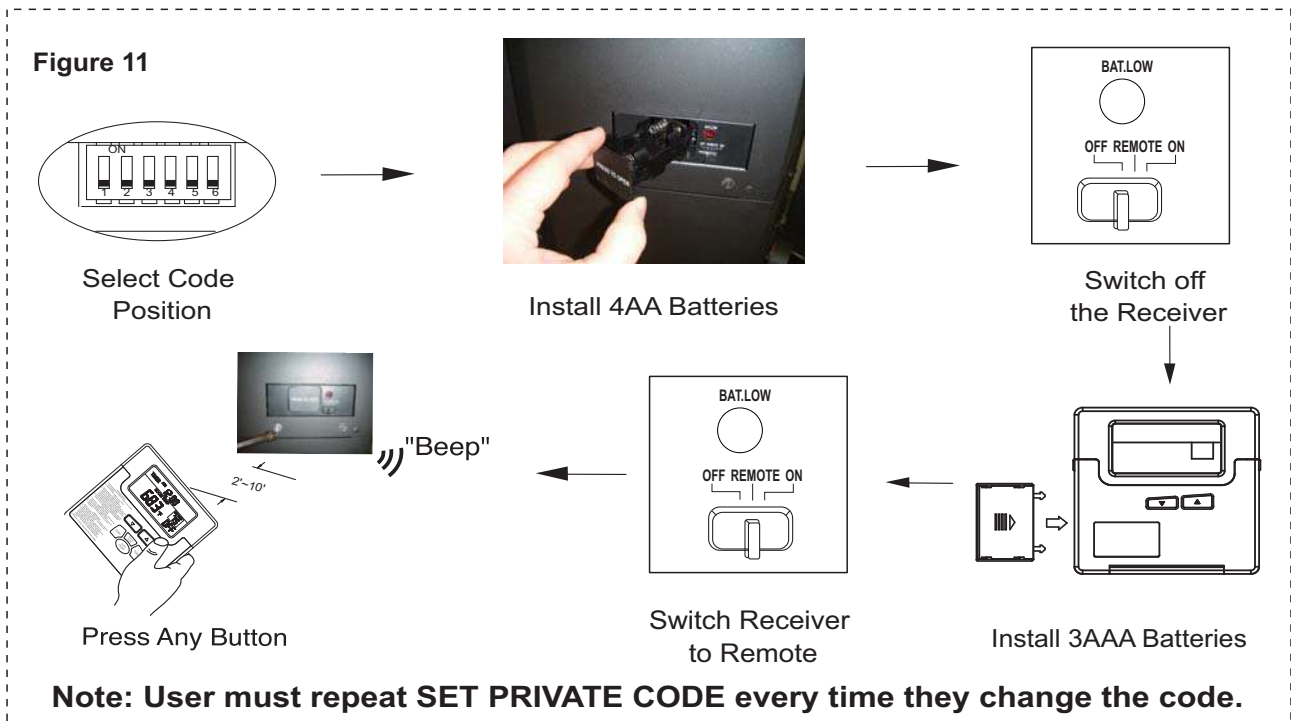

FCC Requirements

Warning: Changes or modifications to this unit not expressly approved by the party responsible for compliance could void the user authority to operate the equipment. This equipment has been tested and found to comply with the limits for a Class B digital device, pursuant to Part 15 to the FCC Rules. These limits are designed to provide reasonable protection against harmful interference in a residential installation. This equipment generates, uses, and can radiate radio frequency energy and, if not installed and used in accordance with the instructions, may cause harmful interference to radio communications. However, there is no guarantee that interference will not occur in a particular installation. If this equipment does cause harmful interference to radio or television reception, which can be determined by turning the equipment off and on, the user is encouraged to try to correct the interference by one or more of the following measures:

Reorient or relocate the receiver antenna.

Increase the separation between the equipment and receiver.

Connect the equipment into an outlet on a circuit different from that to which the receiver is connected

Consult the dealer or an experienced radio TV technician for help.

Canadian Equipment Requirements

This digital apparatus does not exceed the (class A/Class B)* limits for radio noise emissions from digital apparatus set out in the Radio Interference Regulations of the Canadian Department of Communications. Le present appareil numerique n'emet pas de bruits radioelectriques depassant les limites applicables aux appareils numeriques (de la class A/de la class B)* prescrites dans le Reglement sur le brouillage radioelectrique edicte par le ministere des Communications du Canada.

This device complies with RSS-210 of Industry and Science Canada. Operation is subject to the following two conditions: (1) this device may not cause interference, and (2) this device must accept any interference, including interference that may cause undesired operation of the device.

All wiring should be done by a qualified electrician and shall be in compliance with local codes and with the National Electric Code ANSI/NFPA No. 70-current (In the United States), or with the current CSA C22.1 Canadian Electric Code (in Canada).