



33 DVI, Cypress, DVL NB Log Set Installation Instructions (sku 94500561)

Compatibility

- 33 DVI Insert (with no media – 98400097)
- Cypress Stove
- DVL NB with Dancing-Fyre Burner

Packing List

- Rear Log
- Left Log
- Right Log
- Left Twig
- Right Twig
- (2) Log Chunks
- Rockwool
- (2) 4 oz. Bags of Embers

Installation

WARNING:

- **The logs are fragile, especially after being exposed to heat.**
- Make sure the gas control valve is “OFF” and the heater is cool prior to conducting service.
- Failure to position the parts in accordance with these diagrams or failure to use only parts specifically approved with this appliance may result in property damage or personal injury.
- The burner must be correctly positioned before installing the logs. Make sure the burner is fully seated and the pilot is properly aligned. See the owner’s manual for details on burner removal.
- **Make sure the pilot shield and log plate are in place before installing the log set. It is shipped with the burner.**

HINT: If using propane (LP), convert the appliance before installing the log set.

Burner Air Deflector

Before placing the logs, make sure the burner air deflector is in the vertical position (see illustration to the right).

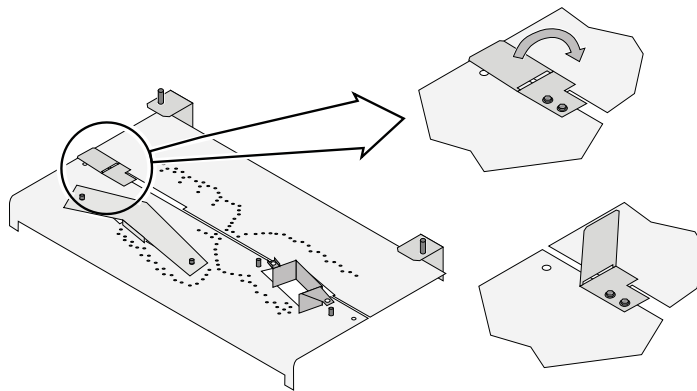

CYPRESS WITH LP (PROPANE)

Rear Log Spacers

If using LP (propane), place the rear log spacers (included with the Cypress in the LP conversion kit) as shown to the right.

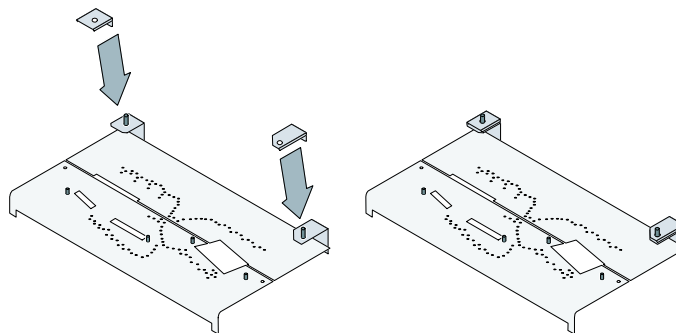

33 DVI, Cypress, DVL NB Log Set Installation Instructions (sku 94500561)

Rear Log Placement

NOTE: The air deflector is used for natural gas (NG) configurations only. The air deflector is shipped with the burner.
IMPORTANT: Make sure the log plate and the pilot shield are in place.

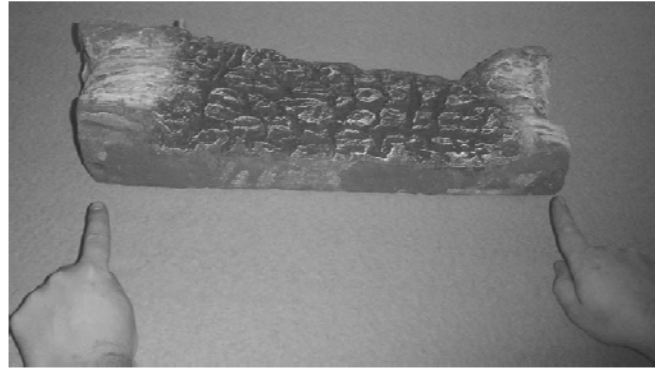

The rear log has two holes on the bottom that fit over the two pins on the burner as shown above.



33 DVI/Cypress Log Set Installation Instructions (sku 94500561)

Left Log Placement

Left Log Plate and Pilot Shield

NOTE: The left log plate and pilot shield are part of the burner assembly but are not mechanically attached. Make sure both components are in place before placing the logs.

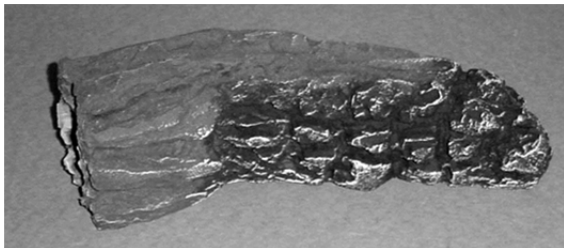
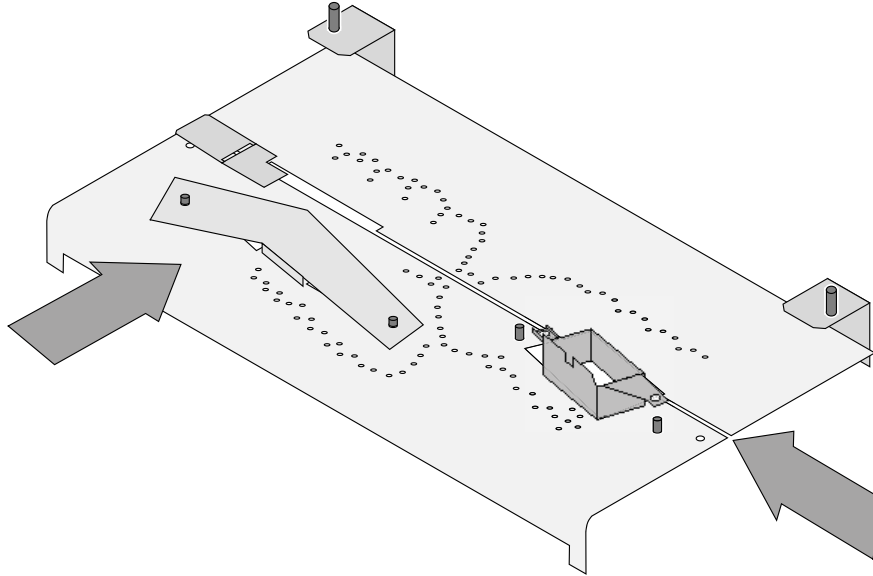

The left log has two holes in the bottom that fit over the pins on the burner as shown above.

33 DVI, Cypress, DVL NB Log Set Installation Instructions (sku 94500561)

Right Log Placement

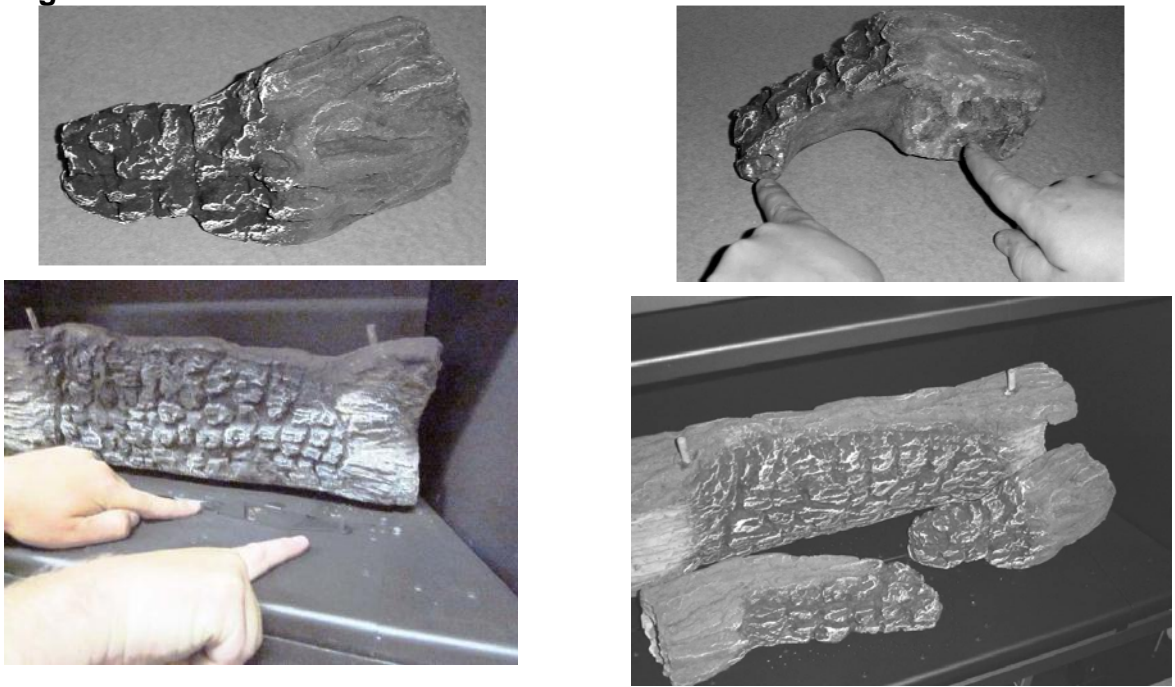

The right log has two holes in the bottom that fit over the two pins on the burner. Place the log as shown above.

Left Twig Placement

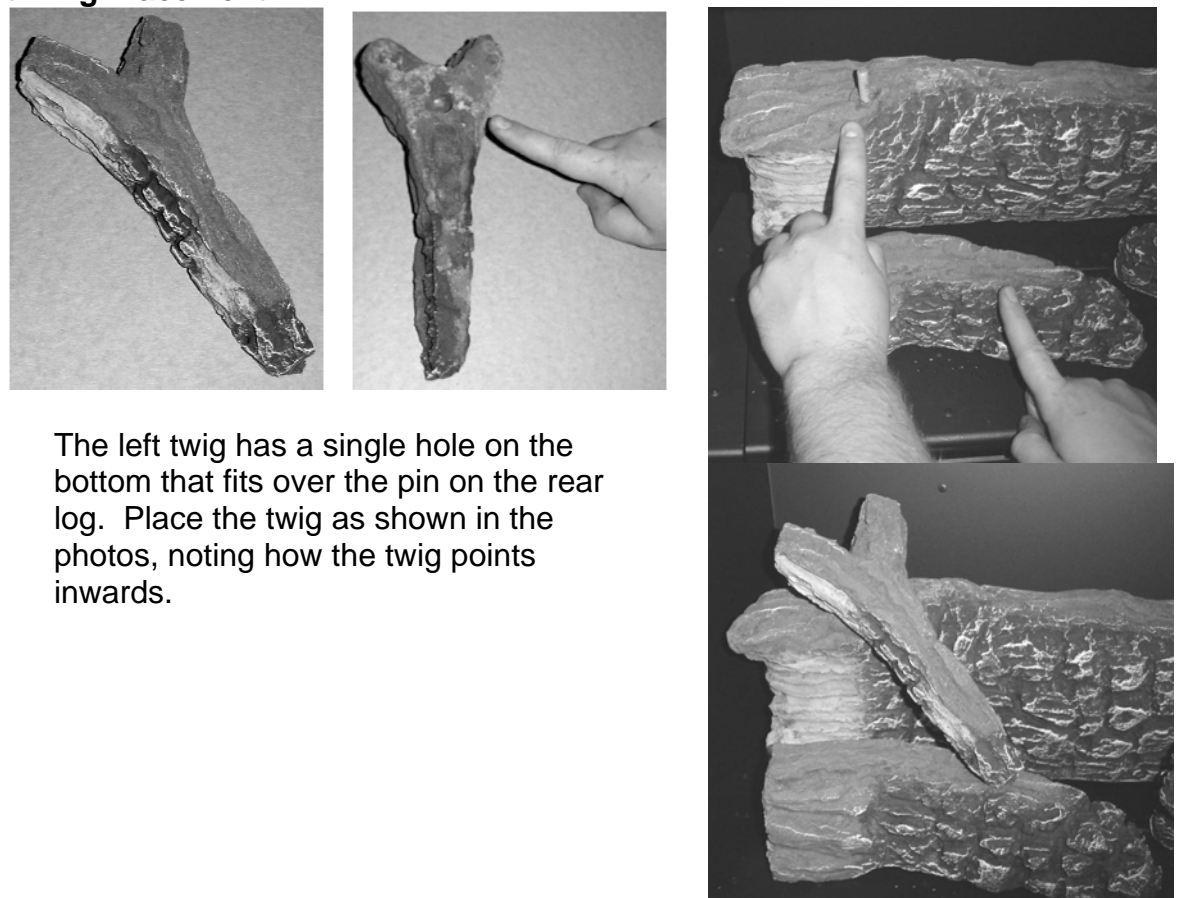

The left twig has a single hole on the bottom that fits over the pin on the rear log. Place the twig as shown in the photos, noting how the twig points inwards.

33 DVI, Cypress, DVL NB Log Set Installation Instructions (sku 94500561)

Right Twig Placement

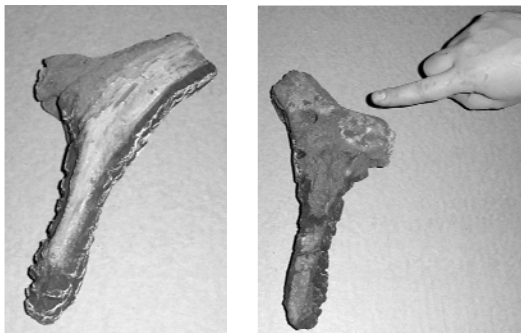

The right twig has a single hole on the bottom that fits over the pin on the rear log. Place the twig as shown in the photos, noting how the twig points inwards.

NOTE: The front of the twig may not contact the right log – this is normal.

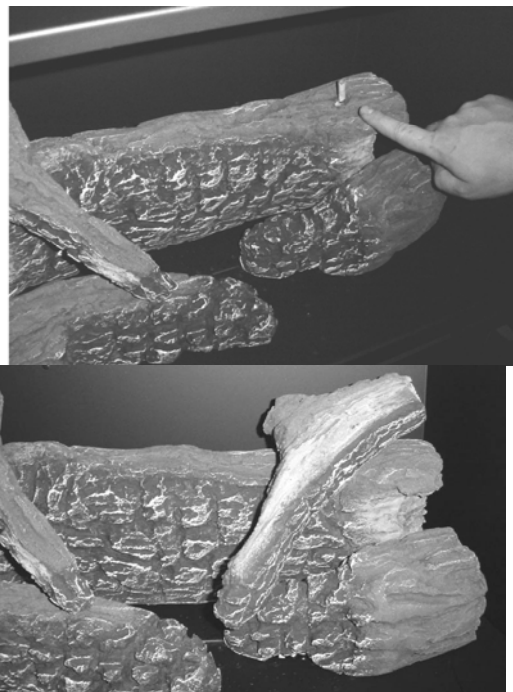

Log Chunk Placement

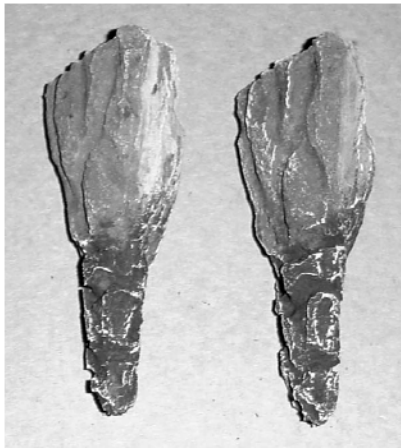

There are two log chunks that are identical. Place them at the front of the burner as shown in the photos. Make sure to not cover any burner holes.

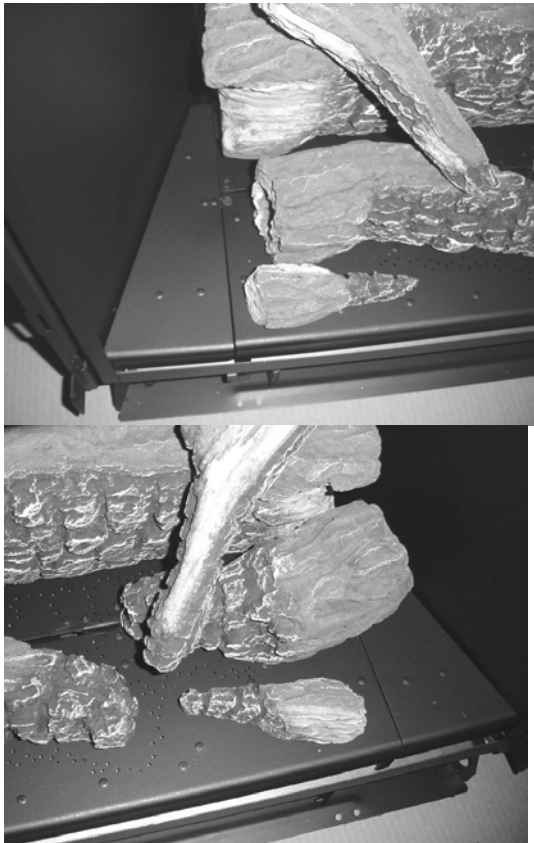



33 DVI, Cypress, DVL NB Log Set Installation Instructions (sku 94500561)

Rockwool Installation

The included rock wool is placed on top of the burner to enhance the glow from the burner. **The rock wool works best when it is applied in a very thin, porous layer.** The best method for applying the rock wool is to brush it on to the burner. Compress a clump of rockwool between your thumb and forefinger. Use a stiff brush to apply a thin layer of rockwool fibers onto the burner. Do not use the entire bag of rockwool. Use only a small amount and save the remainder. Over-use of rockwool will diminish the glow and may cause sooting or other adverse conditions.

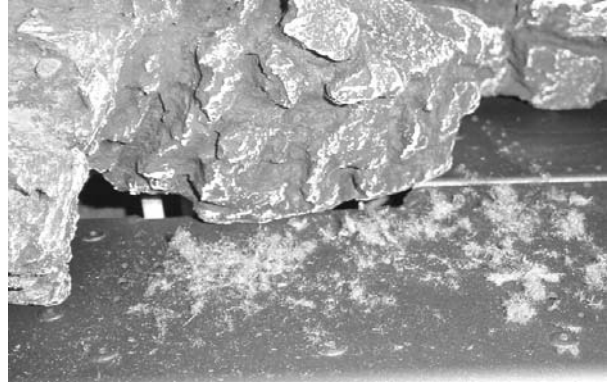

Ember Placement

Place a layer of embers along the edges of the burner, rivets, and along any edges to enhance the aesthetics of the firebox. Do not place embers over any burner holes. See the photo to the right.

33DVI - Use one (1) bag of embers

Cypress - Use two (2) bags of embers



The completed log installation is shown below.

